

GREG DONAHUE
COLLECTOR CAR RESTORATIONS, INC.

NEW PRODUCTS

SUPPLEMENT #1 CATALOG #30A

MECHANICAL AND ELECTRICAL

1963/64

CLUTCH PEDAL RETRACTING SPRING
(Under Dash)
All 4-Speed, 3-Speed, 3-Speed Overdrive
8 15/16" Long 16½ Coils

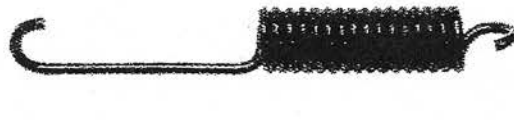

C2AZ-7534A

\$24.50

1963/64

CLUTCH PEDAL ASSIST SPRING INSULATOR
Donut shaped insulator that mounts on clutch
Pedal under the dash. Clutch pedal assist spring
Connects to this insulator.
Originally made out of plastic. We produced these
In brass so that they will not wear out or break.
All 4-Speed, 3-Speed, 3-Speed Overdrive

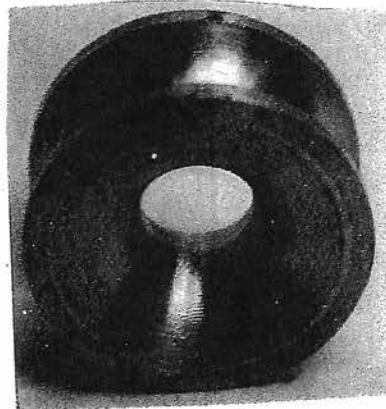

C1AA-7A630A

\$25

1963/64

**EXHAUST MANIFOLD TO H-PIPE GASKET
WITH CAST IRON HEADERS**

All 427-406-390

2 Bolt Holes 2.60" I.D.

3.50 Center of bolt hole to center of bolt hole

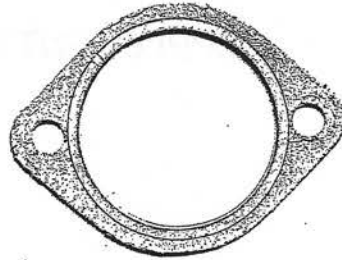

C0AA-9450A

\$9.50

1963/64

**HOOD TO COWL GROUND STRAP
WITH SCREWS**

Mounts on passenger side of cowl
and grounds to the hood.

All Models



C3AA-18870A

\$9

1963/64

**PITTMAN ARM
Manual Steering**



C3AZ-3590B

NOS

\$100

1963/64

SPARK PLUG WIRE SET

427 - 406 - 390 - 352

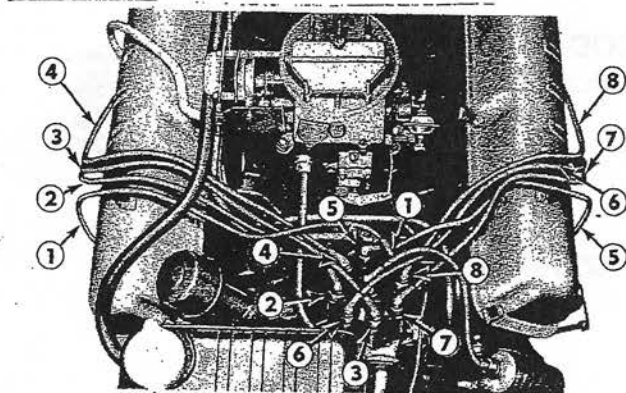

These Sets are custom made to fit. They include all 8 spark plug wires, the coil wire and correct routing instructions. The plug wires are the correct diameter black wire with correct style black spark plug boots and 90° black coil boots. They are made to route and fit original equipment ignition systems.

C3AZ-12259	All Standard Applications	\$51.95
C3AZ-12259CC	Copper Core for Racing Applications	\$65.95

IMPORTANT: These spark plug wire sets are made to fit only the original style ignition systems with the correct 63/64 Big Block valve covers with the spark plug mounting brackets in the first third of the valve cover on each side. The wire sets **will not fit** the early 58 to 62 valve covers with the brackets in the center of the valve cover. They **will not fit** the later 65 and up pentroof valve covers and they **will not fit** any custom or aftermarket cast aluminum, steel or cobra style valve covers. They are made for stock applications only.

ACCESSORIES AND DETAILING ITEMS

1963 HOOD LATCH
All Models



C3AZ-16700A

NOS

\$85

CLIPS, SCREWS, BOLTS AND RELATED ITEMS

1963 GRILLE MOUNTING BOLT AND NUT
Special caged bolt with retaining clip
5/16-24x3/4
Snaps into lower grille and holds grille to
Front stone deflector
4 Required

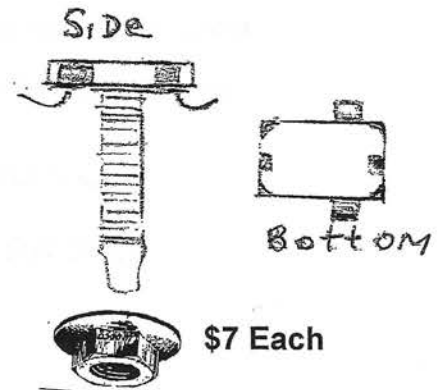

C3AZ-8203A

NOS

\$7 Each

4-SPEED, 3-SPEED, AUTOMATIC AND RELATED ITEMS

1963/64 4-SPEED SHIFT BOOT WITH CONSOLE
Late Style
3 13/16 x 5 11/16 x 3/4 x 5 15/16
Bolt pattern hole to hole



C4AZ-7277B

\$60

INTERIOR

1963/64 PARKING BRAKE RELEASE HANDLE
Replacement



B9AZ-2760AR

\$15

LOCKS AND RELATED ITEMS

1963 TRUNK LOCK CYLINDER AND KEYS
All Models Except Station Wagons with Manual
Tailgate Window

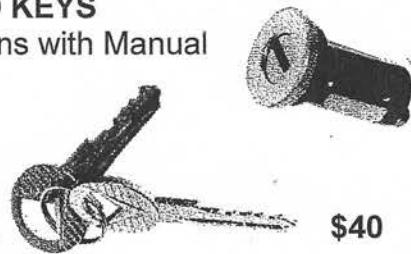

C2DZ-5943505B

\$40

1963 TRUNK LOCK BEZEL
All Models Except Station Wagon



C2AZ-6243603A

\$60

1964 TRUNK LOCK BEZEL
All Models Except Station Wagon

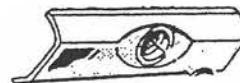

C4AZ-6243603A

\$75

SWITCHES

1963/64

TAILGATE LIMIT SWITCH
All Wagons



C3AZ-14A011B

NOS

\$75